



①: Power adjustable

②: Smart plug & play system for build-in sensor
—without wiring and without tool



Low Glare—UGR<22 & Save SKU

Key Features

- Power adjustable
- Smart plug & play system without wiring for build-in sensor
- Low glare, UGR<22
- Save SKU
- Both motion sensor and PIR sensor optional
- High Efficiency up to 170lm/W
- 5 years warranty

Applications

- Warehouse
- Industrial Facility
- Exhibition Center
- Shopping Mall
- Gymnasium
- Airport
- Toll Station and so on.

Specifications

Model No.	HB09-100W	HB09-150W	HB09-200W
Power Consumption	80W-150W Adjustable	80W-150W Adjustable	120W-200W Adjustable
High efficiency version	170 LM/W		
Luminous Flux (±10%)	17000±1000lm	25500±1500lm	34000±2000lm
CCT	3000K;4000K;5000K;6000K		
Color Rendering Index	Ra70 / Ra80 / Ra90		
Beam Angle	80°(low glare) & PC lens 90°/120°		
Power Supply	TOMCARLINE		
Input Voltage	100-277 VAC / 277-480VAC		
Power Factor	>0.95		
Frequency	50 / 60 Hz		
Surge Protection	L-N: 4KV; L/N-GND: 6KV		
Driver Type	Constant Current (CC)		
Product Dimension (mm/inch)	Φ320*188		
Luminaire Net Weight	3.8kg		
Export Carton Size	37*37*23(cm)		
Gross Weight	4.8kg		
Material	Housing	Aluminum Alloy	
	Optics	Polycarbonate Optical Lens	
Finish	Powder Coating		
Fixture Color	Black		
Mounting Option	Round Ring Mounting / Yoke Mounting		
Ambient Temperature	-30~+50℃		
Life Time	50.000 hours		
Warranty	5 Years		
Dimmable	1-10V dimmable, Dali dimmable		
Accessory	PC lens 90° & 120°		
	PC reflector		
	Surface mounting/wall mounting bracket		
	Safety rope (0.5m length)		
Intelligent Control	Plug-and-Play PIR or Microwave motion sensor available		

Photometry

80°(Low Glare)

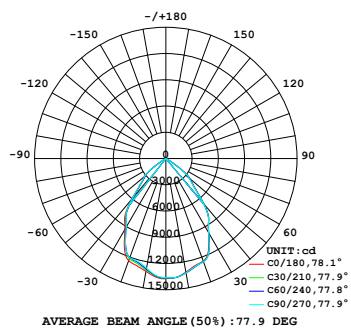

90°

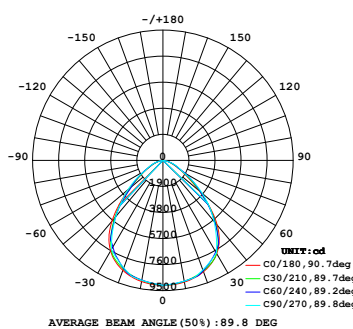

120°

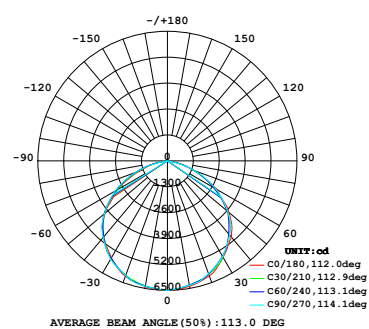

Mounting Options

Round Ring Mounting



Yoke Mounting



Dimensions

HB09-100W/150W/200W

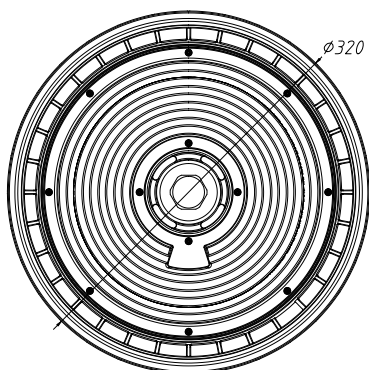
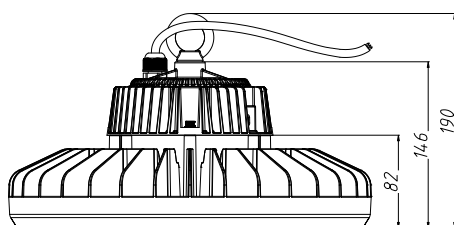

Accessories

TOMCARLINE



480V driver

TOMCARLINE



1-10V dimmable, Dali dimmable



Plug-and- play microwave motion sensor & Remote control



Plug-and- play PIR sensor & Remote control



1.5m dimmable cable

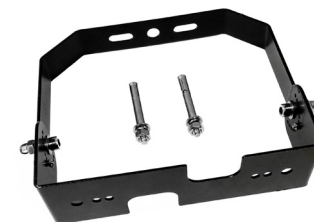

Surface/wall mounting bracket



Safety rope (0.5m length)

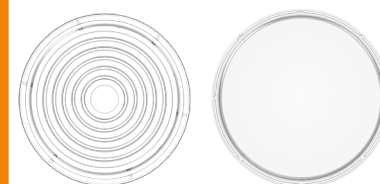

PC lens 90° & 120°

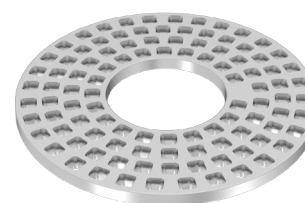

Honeycomb reflector baffle



PC reflector